

PVP-Series Biotube® Pump Vaults

For use with Orenco 4in (100mm) Submersible Effluent Pumps

Applications

Orenco's patent-pending PVP-Series Biotube Pump Vaults are ideal for liquid-only sewer (LOS) systems and on-site wastewater treatment systems. The pump vault keeps sludge and scum away from the filter, pump, and float switches, while the filter removes particles 1/8in (3.2mm) or larger from the clear zone. This reduces suspended solids by two-thirds, on average, and allows clear effluent to be discharged.* Pump vaults also house one or two Orenco high-head effluent pumps and can be used in single-compartment septic tanks with flows up to 40gpm (2.5L/s). When flows are greater than 40gpm (2.5L/s), a double-compartment septic tank or separate dosing tank is recommended.



General

The Orenco PVP-Series Biotube Pump Vault includes a molded polyethylene housing and an internal Biotube filter cartridge constructed of polypropylene and PVC. The passively self-cleaning design extends maintenance cycle intervals. The filter cartridge can be removed without pulling the pump or the vault. PVP-series vaults can accommodate one or two high-head effluent pumps.

Standard Models

PVP60-10, PVPP60-10, PVPM52-10, PVPMP52-10

Product Code Diagram

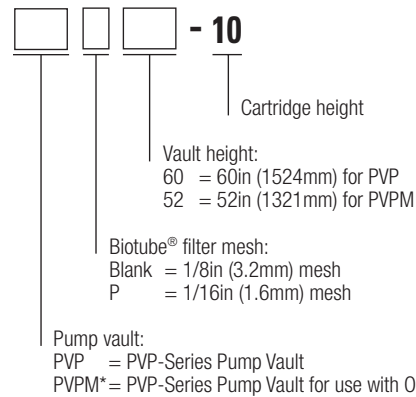

*PVPM52-10 coming soon. Please see PSCM52-10 for current version.

Tank Access and Riser Diameters

Diameter, in (mm)	PVP with simplex pump	PVP with duplex pumps
Tank access, minimum	18 (457)	18 (457)
Tank access, maximum	20 (508)	24 (600)*
Riser, minimum	24 (600)	30 (750)

*An extension kit, product code PVP-AEK, is required for tank access openings larger than 19in (483mm) in 30in (750mm) risers.

* "Filter Facts," Orenco Product Fact Sheet.

Pump Vault

Orenco's patent-pending PVP-Series Biotube Pump Vault is designed to be passively self-cleaning for reduced maintenance and service needs.

Materials of Construction

Vault body	Polyethylene	
Dimensions, in (mm)	PVP	PVPM
A	22 (559)	18.50 (470)
B	16.38 (416)	14.56 (370)
C	60 (1524)	52.50 (1334)
D Inlet height	10.88 (276)	16.94 (430)
E Lowest float setting point	32 (813)	20.5 (521)

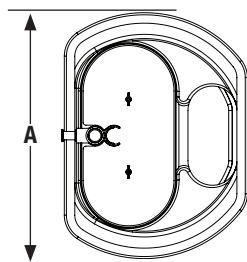

PVP-series pump vault, top view

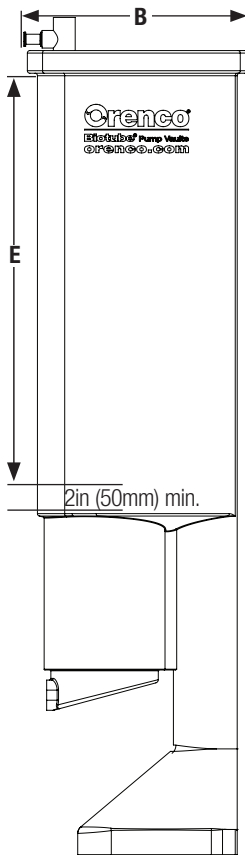

PVP-series pump vault, side view

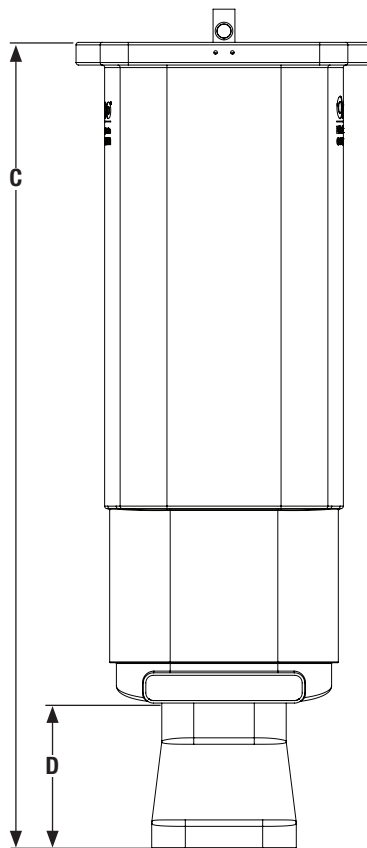

PVP-series pump vault, front view

Biotube Filter

The Orenco PVP-Series Biotube filter is designed for effective filtration of effluent and passive self-cleaning for long cleaning intervals.

Materials of Construction

End plates	DCPD	
Filter tubes	Polypropylene	
Handle assembly	Sch. 40 PVC	
Screws	Stainless steel	

Dimensions, in (mm)	PVP	PVPM
A	16.50 (419)	16.31 (414)
B	10 (254)	10 (254)

Performance	PVP60-10	PVPM52-10
Biotube mesh, in (mm)*	0.125 (3)	0.125 (3)
Total filter flow area, ft ² (m ²)	4 (0.37)	4 (0.37)
Total filter surface area, ft ² (m ²)	14 (1.3)	14 (1.3)

*0.062in (1.6mm) filter mesh available

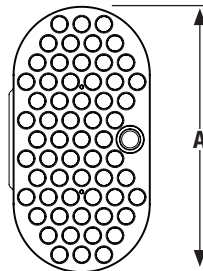

Biotube filter cartridge, top view

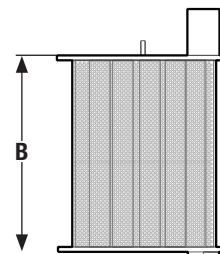

Biotube filter cartridge, side view

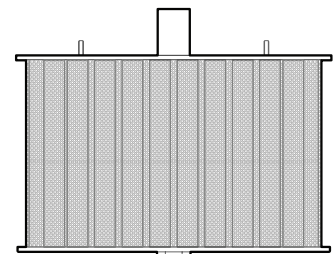

Biotube filter cartridge, front view

Pump Vault Adapter Extension Kit

The Orenco PVP-Series Biotube Pump Vault Adapter kit is required when using a 30in (750mm) riser with an access opening larger than 19in (483mm). The kit contains 2 brackets, 6 nuts, and 6 bolts.

Materials of Construction

Support brackets	Fiberglass reinforced polymer
Nuts and bolts	Stainless steel

Dimensions, in (mm)

A	14 (356)
B	6.5 (165)
C	5.5 (127)
D	27.9 (709)

Product Code Diagram

PVP - AEK

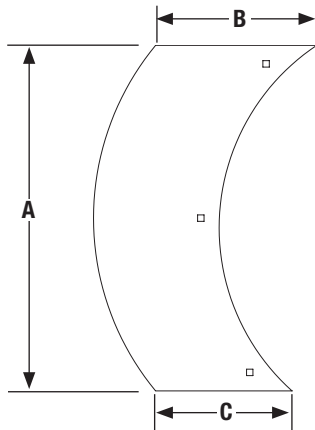

Single bracket from adapter kit

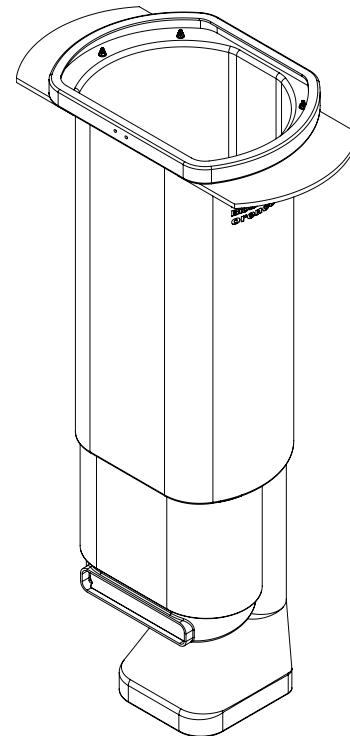

Adapter kit installed, isometric view

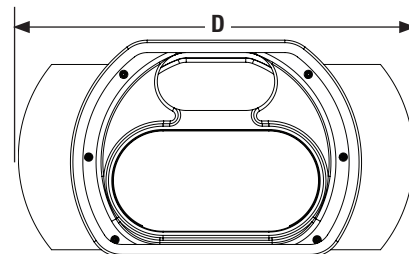

Adapter kit installed, top view